

AGD 641

PEDESTRIAN DETECTOR

PRODUCT MANUAL

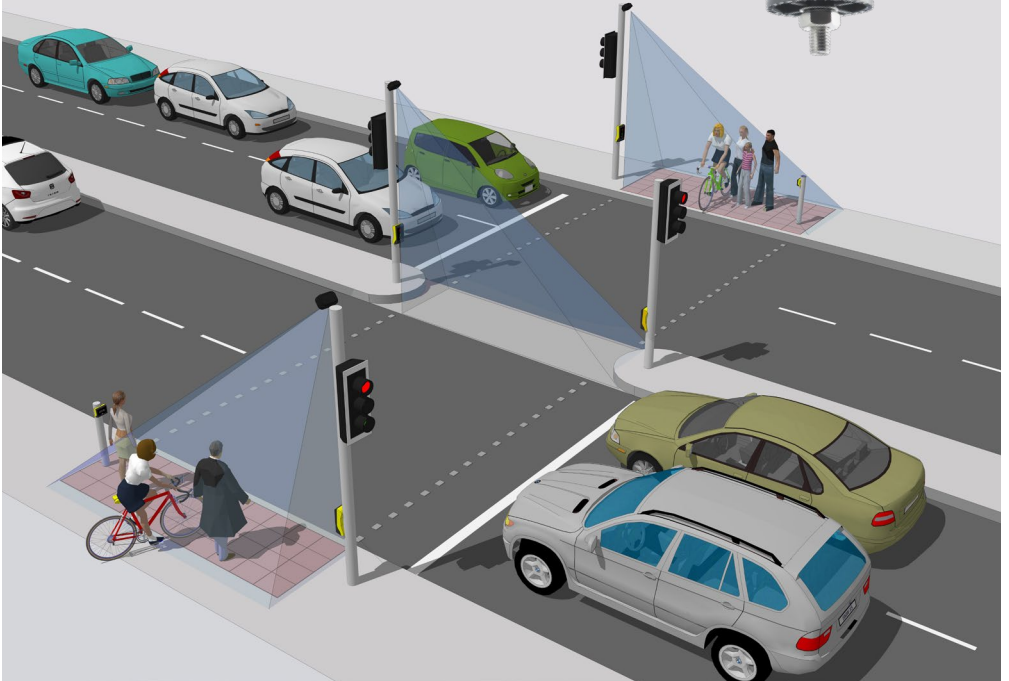

© AGD Systems Limited 2019 Doc. Ref 641 PM ISS1



AGD Touch-setup ✓
WIFI 3-CLICK TOUCH-SETUP

AGD[®]

PRODUCT SOLUTIONS FOR
INTELLIGENT TRAFFIC SYSTEMS

Table of Contents

AGD 641 PEDESTRIAN DETECTOR

| | | | |
|--|----|---|----|
| INTRODUCTION | 3 | TECHNICAL RESOURCE | 11 |
| Product and technology | 3 | Physical installation | 11 |
| Key features | 3 | | |
| Typical applications | 3 | TROUBLESHOOTING | 12 |
| Product overview image | 4 | Physical installation | 12 |
| Product variants | 4 | Electrical installation | 12 |
| Product overview | 4 | Connecting / Commissioning | 12 |
| INSTALLATION AND COMMISSIONING | 5 | TECHNICAL SPECIFICATIONS | 13 |
| Physical Installation | 5 | Product Dimensions | 13 |
| Step 1 – Mounting height | 5 | Specification | 13 |
| Step 2 – Detector alignment | 5 | | |
| Step 3 – Detector view | 5 | END OF LIFE DOCUMENT | 14 |
| Electrical Installation | 6 | | |
| Connections | 6 | IMPORTANT SAFETY INFORMATION | |
| Opto-Coupler Ratings | 6 | Safety precautions | 15 |
| Power Up Sequence | 6 | Low power non-ionising radio transmission and safety | 15 |
| Connecting | 7 | | |
| Connecting Wifi | 7 | CERTIFICATES | 16 |
| Connecting device | 7 | | |
| Set-up device using Wifi AGD Touch-setup | 8 | DISCLAIMER | 20 |
| Step 1 – Name site | 8 | Warranty | 20 |
| Step 2 – Set zone | 8 | Contact Details | 20 |
| Step 3 – Calibrate | 9 | | |
| Home page | 9 | | |
| Optional Parameters | 10 | | |



AGD Touch-setup
WIFI 3-CLICK TOUCH-SETUP

safer, greener, more efficient

Introduction

AGD 641 PEDESTRIAN DETECTOR

PRODUCT AND TECHNOLOGY



The AGD641 Pedestrian Detector has been designed for the detection and monitoring of pedestrians and cyclists waiting to cross the road to ensure the crossing phase is only called when they are present in the wait area.

The AGD641 is a replacement for the AGD640 Pedestrian Detector which has successfully been deployed on over 15,000 sites worldwide. The ground-up development of the 641 is a 3D stereo-vision optical system capable of detecting moving and stationary targets over a 4m x 2m zone. The 641 maintains class leading shadow and unwanted object rejection.

KEY FEATURES

- 4m x 2m zone adjacent to the detector saving on infrastructure costs.
- AGD 3D optical stereo vision technology provides greater performance even at low light levels.
- WiFi AGD Touch-setup technology with 3 step browser setup speeds up installation and reduces installer risk.
- Flexible polygon tool allows easy configuration of curved or irregular detection zones saving time on site.
- Compatibility with old and new controllers makes the AGD641 an ideal solution for any site.
- In built Infra-red illuminator.

TYPICAL APPLICATIONS

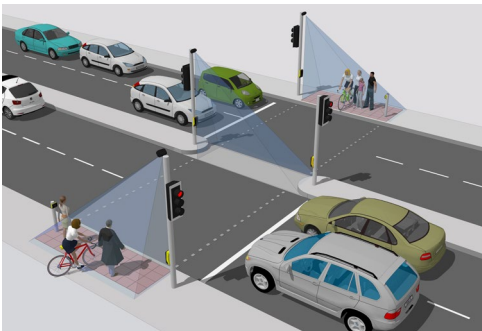

4m x 2m Toucan Crossing

Introduction

AGD 641 PEDESTRIAN DETECTOR

PRODUCT OVERVIEW IMAGE

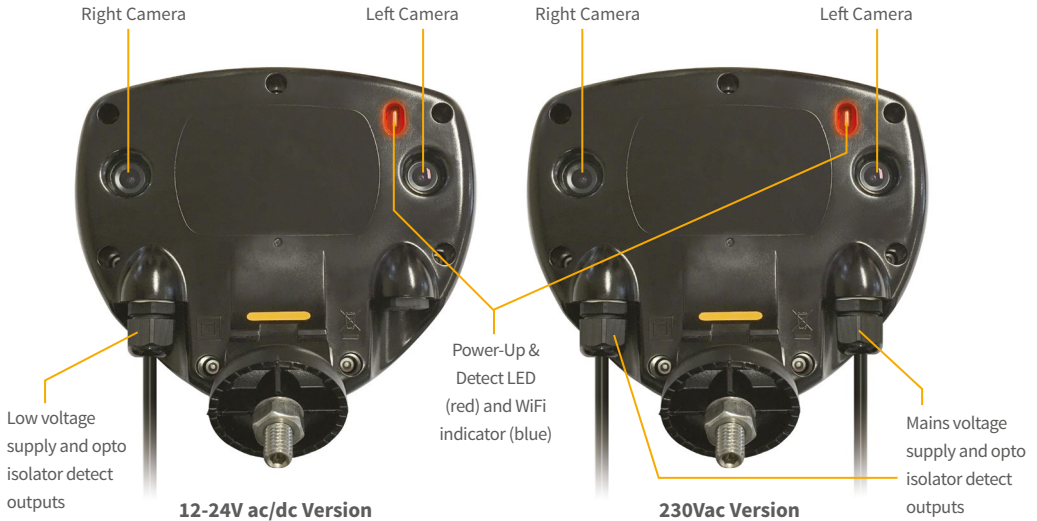

PRODUCT VARIANTS

| Product No. | Description |
|-------------|--|
| 641-500-021 | Pedestrian Detector / 12-24V ac/dc / WiFi / Single Opto Output/1m lead / 1m bulkhead mating lead |
| 641-503-021 | Pedestrian Detector / 12-24V ac/dc / WiFi / Single Opto Output / 5m flying lead |
| 641-504-021 | Pedestrian Detector / 12-24V ac/dc / WiFi / Single Opto Output / 1m lead / 4m bulkhead mating lead |
| 641-300-021 | Pedestrian Detector / 230Vac / WiFi / Single Opto Output / 5m flying leads |

PRODUCT OVERVIEW

The AGD641 Pedestrian Detector is an optical product that makes pedestrian crossings safer by delivering robust detection within a standard crossing zones. Multiple units easily integrate to cover larger wait areas.

It is a high-performance product that processes information on board with a new chip-set and sophisticated algorithms, automating decision-making to provide ultra-reliable detection.

The AGD641 Pedestrian Detector employs a 3D stereo vision optical system that detects moving and stationary targets over a 4 x 2m zone. It has an outstanding capability to detect people while rejecting shadows, litter, leaves and small objects such as birds walking through the zone.

It has Infra-red illumination for night time operation.

Installation and Commissioning

AGD 641
PEDESTRIAN DETECTOR

PHYSICAL INSTALLATION

STEP 1 - MOUNTING

HEIGHT – The AGD641 Pedestrian Detector has excellent performance when mounted between heights of **3-4 metres**.

If you have an application whereby you wish to mount the detector outside of these heights, then please contact AGD.

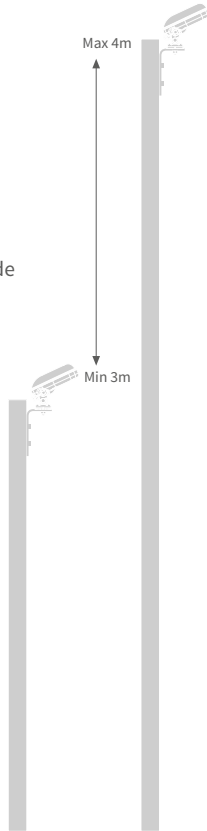

STEP 2 - DETECTOR ALIGNMENT – The AGD641 Pedestrian Detector should be mounted using the supplied hardware. Adjust the tilt angle to be 45 degrees from the horizontal +/- 15 degrees to see a point 4m from base of pole when viewed from the detector. Ensure that the detector is securely fixed and the mounting nut is tight.

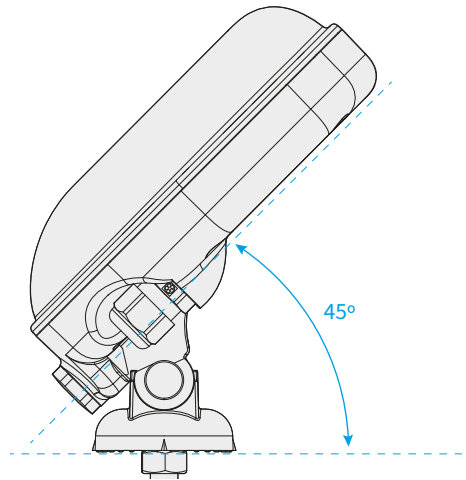

STEP 3 - DETECTOR VIEW – View the zone-area *from* the detector, including the area directly in front of the push button. Obstruction of the zone-area by signal head backing boards, moving foliage or anything else **must** be avoided so that the detector has a clear field of view.

Detector Alignment – Further adjustment may be required in occasional circumstances to accommodate particular site conditions.

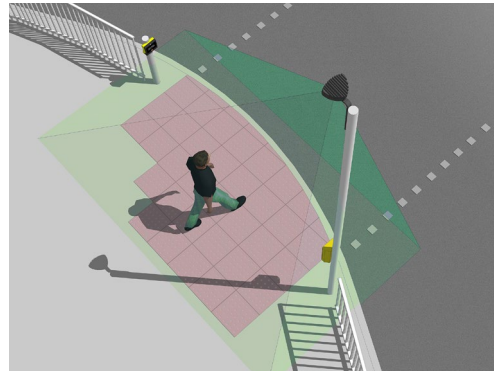

Installation and Commissioning

AGD 641 PEDESTRIAN DETECTOR

ELECTRICAL INSTALLATION

The detector is powered using a 12-24V ac/dc ($\pm 20\%$) or 230Vac supply. For the non mains units the power is applied to the detector using the multi-pin mating connector.

The AGD641 Pedestrian Detector is provided with a Buccaneer Series PX0728/S 9 pole connector to enable direct connection to the traffic control system. The pin outs of the connector and detector function are highlighted in the table below:



CONNECTIONS FOR 12V-24V ac/dc VERSIONS

| Pin No. | Wire Colour | Function | Power Off | Power On- No Detect | Power On- Detect | |
|---------|-------------|-----------------|-----------|---------------------|------------------|--------------------------------|
| 1 | RED | 12-24V ac/dc | - | - | - | - |
| 2 | BLACK | 0V ac/dc | - | - | - | - |
| 3 | GREEN | Earth/Ground | - | - | - | - |
| 4 | WHITE | Opto 1/2 Common | - | - | - | - |
| 5 | YELLOW | Opto 1 N/O | N/O | N/C | N/O | - |
| 6 | BLUE | Opto 1 N/C | N/C | N/O | N/C | Not for use on Puffins/Toucans |
| 7 | - | - | - | - | - | - |
| 8 | BROWN | Not Connected | - | - | - | - |
| 9 | VIOLET | Not Connected | - | - | - | - |

CONNECTIONS FOR 230Vac VERSION

| Twin Cable 230Vac Supply Wiring (5m flying leads) | | | | | |
|---|-------------|----------------|-----------|----------------------|-------------------|
| Cable | Wire Colour | Function | Power Off | Power On - No Detect | Power On - Detect |
| Power | Brown | 230Vac Live | - | - | - |
| | Blue | 230Vac Neutral | - | - | - |
| Signal | Red | Opto Common | - | - | - |
| | Blue | Opto Contact | N/C | N/O | N/C |
| | Green | Opto Contact | N/O | N/C | N/O |

OPTO-COUPLER RATINGS FOR ALL VOLTAGE VERSIONS

- Max current 60mA
- Max Voltage 100V
- Max on-state impedance 25 Ohms

| Power supply ratings | 12Vac | 24Vdc | 24Vac | 230Vac |
|----------------------|-------|-------|-----------|---------|
| Day time mode | - | - | 170mA | 17mA |
| Night time mode | 300mA | 140mA | 200/255mA | 24/30mA |

POWER UP SEQUENCE

After applying power to the unit, the front red LED will permanently illuminate for approximately 30 secs while the operating system loads. The LED will then start flashing and either extinguish if the detector has been previously set-up and revert to normal operation (illuminated if zone is in detect, not illuminated if zone is empty), or the LED will continue to flash until the unit has been set-up and commissioned.

Installation and Commissioning



CONNECTING

The AGD641 Pedestrian Detector has been designed with efficiency and ease of use in mind. User connect to the detector using a WiFi enabled device (laptop, tablet or phone) and set up simply using a browser window.

This step-through process describes the actions required to set up the detector upon initial deployment when first removed from the box.

CONNECTING WIFI

Check the red LED is illuminated and flashing on the front of the unit. Search for the unit and identify the unit by its **serial number**:

641:XXXXXX-XXXX-TBD (the 'X' denotes the S/N, TBD is a renamable field used to name the pole location the 641 is installed on)

Click 'connect' and input the **default password**:

Agd641:XXXXXX-XXXX (the 'X' denotes the S/N)

The LED on the front of the unit should now be illuminated blue to show WiFi is successfully connected and your device should show connected.

AGD Systems recommend you change the password via the Advanced screen option.

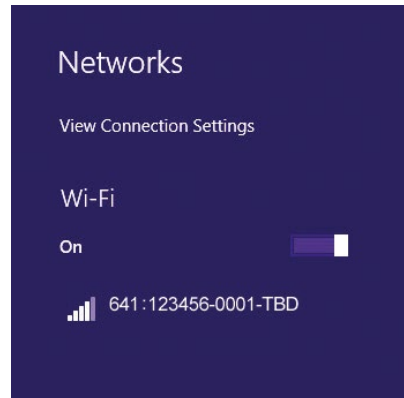

CONNECTING DEVICE

Complete Wifi connection step as above.

Launch a browser on your smartphone, tablet or laptop (Modern versions of Google Chrome are supported - 2018 onwards).

In the address bar of your browser, enter the 'IP Address':
http://10.42.0.1:8080

You will be presented with your initial AGD Touch-setup page.

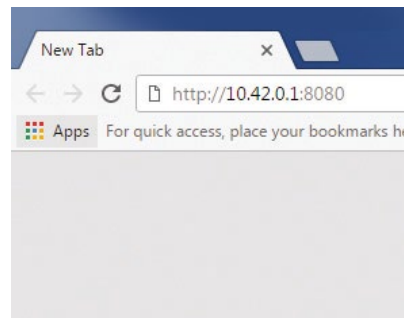

Installation and Commissioning

AGD Touch-setup WIFI 3-CLICK TOUCH-SETUP

SET-UP DEVICE USING AGD TOUCH-SETUP

When logged in to the device for the first time you click set-up. This is the AGD Touch-Setup, a three stage process that allows installers to configure the device quickly and efficiently.

STEP 1 – NAME SITE

The first action is to name the devices '**Install Location**'.

*Note - This will change the SSID of the device (the Wifi name of the device). However, the default password will remain the same unless changed in 'Advanced' settings

When finished naming the '**Install Location**' proceed to the next step by clicking '**Next**'.

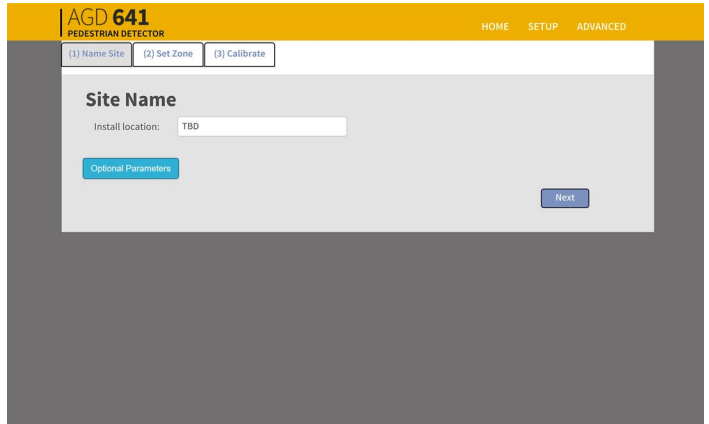

STEP 2 – SET ZONE

The second action is to '**Set Zone**' using the quick-mask 'zone' tool. Draw a boundary around the area in which you are interested in detecting pedestrians. Take care to draw around poles, railings, foliage and other items that might be in the field of view.

Note the extra area that has been drawn around the tactile, this is necessary to provide coverage at the extremities of the zone.

When the zone is set, click '**Next**'.

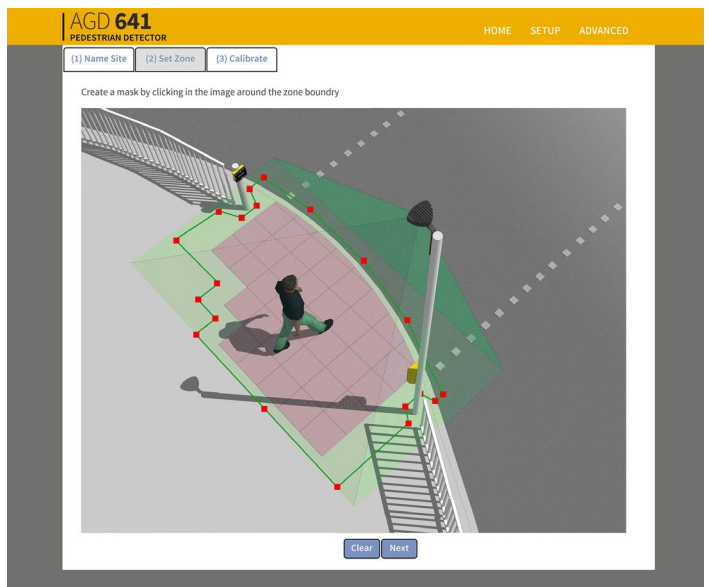

STEP 3 – CALIBRATE

The third and final stage in the set-up is ‘**Calibration**’. Check the selected zone-area, ensure the zone is empty, then click ‘**On-Site Calibration**’.

Successful completion of the calibration will result in the detector returning to the ‘**Home**’ page.

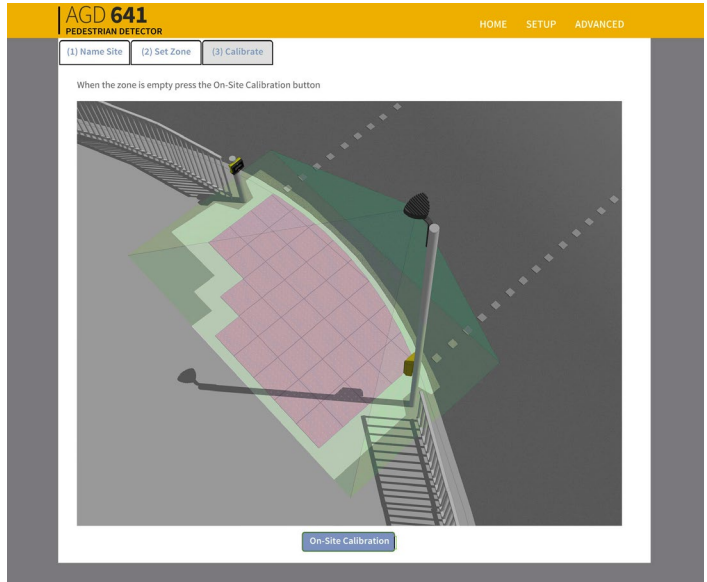

HOME PAGE

Following successful calibration you will view your selected zone actively ‘detecting’ on the ‘Home Page’ - and helpfully, if the detector has been previously setup you will come straight to the Home Page on connection.

The image you see on the screen will be the detect area with any area excluded greyed out. This image will update periodically.

Monitor the zone and check the detector triggers - the front LED will illuminate and extinguish when someone enters and leaves the zone.

A box around the image will illuminate **RED** on Detection.

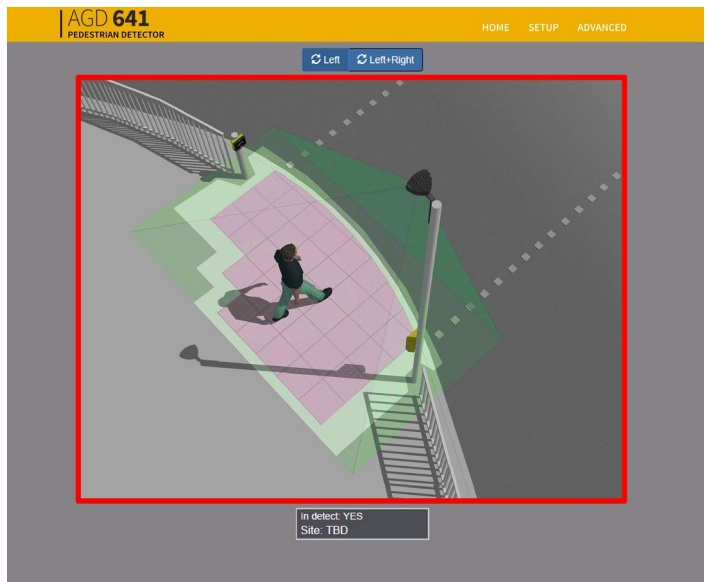

OPTIONAL PARAMETERS

OPTIONAL PARAMETERS

- **Wifi off after 24 hours**

Select this box to disable the WiFi after 24 hours.

The device will need to be power cycled to have the WiFi network viewable after this period

- **Detect LED on at night**

Select this to allow the detector to illuminate the front RED led at night.

- **Hold Time (sec)**

This value denotes the amount of time the detection OPTO output is held **AFTER** a valid target leaves the area of detection.

Input range = 0 - 60 seconds

Default = 2 seconds

- **User notes**

An editable field to allow engineers to store notes in the device.

Max characters = 64 bytes

AGD 641
PEDESTRIAN DETECTOR

HOME SETUP ADVANCED

(1) Name Site (2) Set Zone (3) Calibrate

Site Name

Install location: TBD

Optional Parameters

WiFi off after 24 hours:

Detect LED on at night:

Hold time (sec): 2

User notes: NONE

Next

PHYSICAL INSTALLATION

TYPICAL INSTALLATION PARAMETERS

The AGD641 operates with a high degree of accuracy when mounted inside normal parameters. The diagram below shows a plan view of the expected coverage of the stereo cameras when the detector device is mounted at a height between 3 - 4metres.

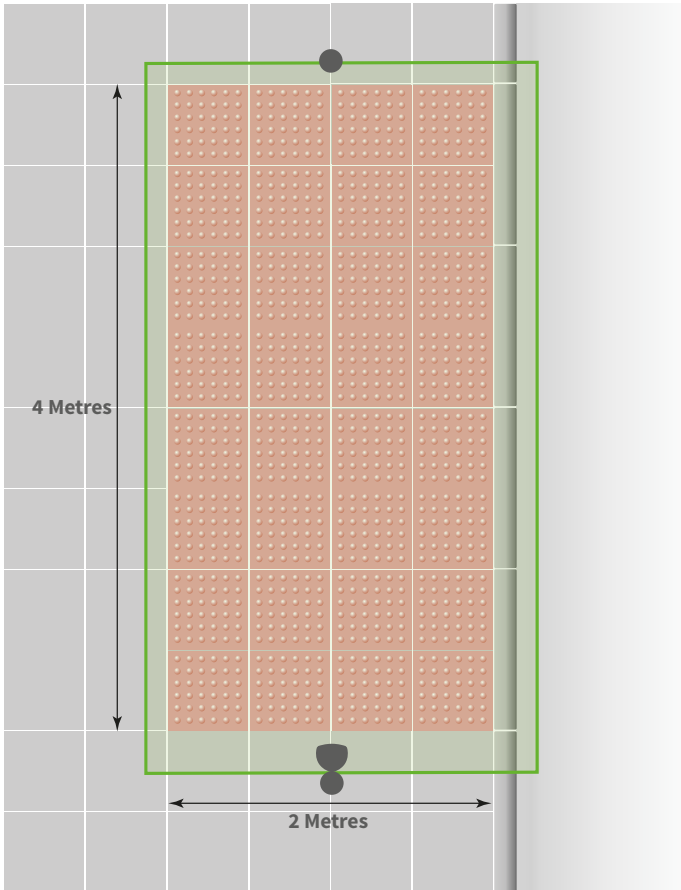

4m x 2m Zone - Illustrated using nominal mounting height of 3 - 4m

PHYSICAL INSTALLATION

If the unit is not operating correctly, please check the following. Has the unit been:

- 1) Mounted within the recommended height of 3 - 4 metres?
- 2) Angled according to the installation guide to provide good coverage of the detection area?
- 3) Installed with any obstructions in the viewable area such as the traffic signal head?

ELECTRICAL INSTALLATION

If the unit is not operating correctly, please check the following:

- 1) Is power present at the unit?
- 2) Is the red LED illuminated when power is applied to the unit?
- 3) Is there sufficient current to run the unit - identified by the red LED failing to flash or flashing only once during power-up and the web page not starting correctly? Refer to technical specification table.

CONNECTING / COMMISSIONING

If the unit is not operating in the prescribed manner, please check the following:

- 1) Is the LED on the front of the unit you wish to connect to illuminated blue to show that the WiFi network is successfully connected?
- 2) Has the correct IP Address been entered into the browser address bar?
- 3) Have you followed the AGD Touch-setup stages correctly and verified correct operation?

If trouble with operation persists please contact AGD Technical Support.

AGD TECHNICAL SUPPORT

eMail: technical@agd-systems.com

Tel: +44-1452 557404

Technical Specifications

AGD 641 PEDESTRIAN DETECTOR

PRODUCT DIMENSIONS

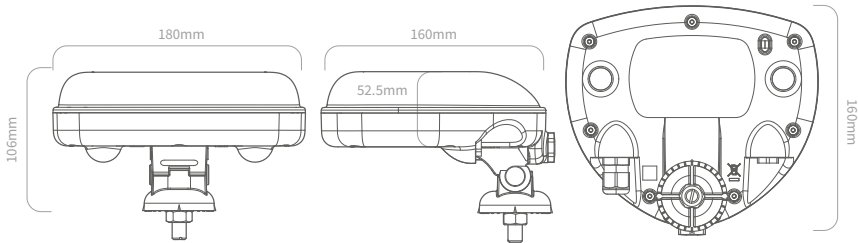

SPECIFICATIONS

| | |
|-----------------------------|--|
| Description | Pedestrian Detector |
| Technology | AGD 3D HD Optical Stereo Vision |
| Detection Zone | 4m x 2m |
| Mounting Height | 3-4m (3.5m nominal) |
| Power Supply | 12 - 24V ac/dc or 230Vac |
| Power | 3.6W @ 12Vdc @ 300mA / 6.9W @ 230Vac @ 30mA 6.1W @ 24Vac @ 255mA / 3.4W @ 24Vdc @ 140mA |
| WiFi Frequency/Power | Frequency range (MHz): 2412-2472 Highest EIRP power in the range (dBm): 19.7 |
| Opto / Relay Current | 60mA |
| Detect Output | Single Opto |
| LED Indication | Front LEDs for detect and WiFi connection |
| Housing Material | Black Polycarbonate |
| Sealing | IP55 |
| Operating Temp | -15°C to +60°C |
| Configuration | WiFi AGD Touch-Setup |
| Lux Level | In built IR illuminator for low light/nighttime |
| Dimensions | W 181mm x D 160mm x H 106mm |
| Weight | 500g |
| Complies with | EMC: BS EN 50293: 2012, EN301 489-17, EN301 489-1 Health & Safety: EN 60950-1, EN 60950-22, EN 50556, EN 62311 Spectrum: EN 300 328. RoHS: EN 50581, TOPAS 2507A |
| Patent No. | GB 2448617 |

Owing to the Company's policy of continuous improvement, AGD Systems Limited reserves the right to change their specification or design without notice.



End Of Life – Disposal Instructions (EOL)

AGD 641
PEDESTRIAN DETECTOR

AGD641 PEDESTRIAN DETECTOR

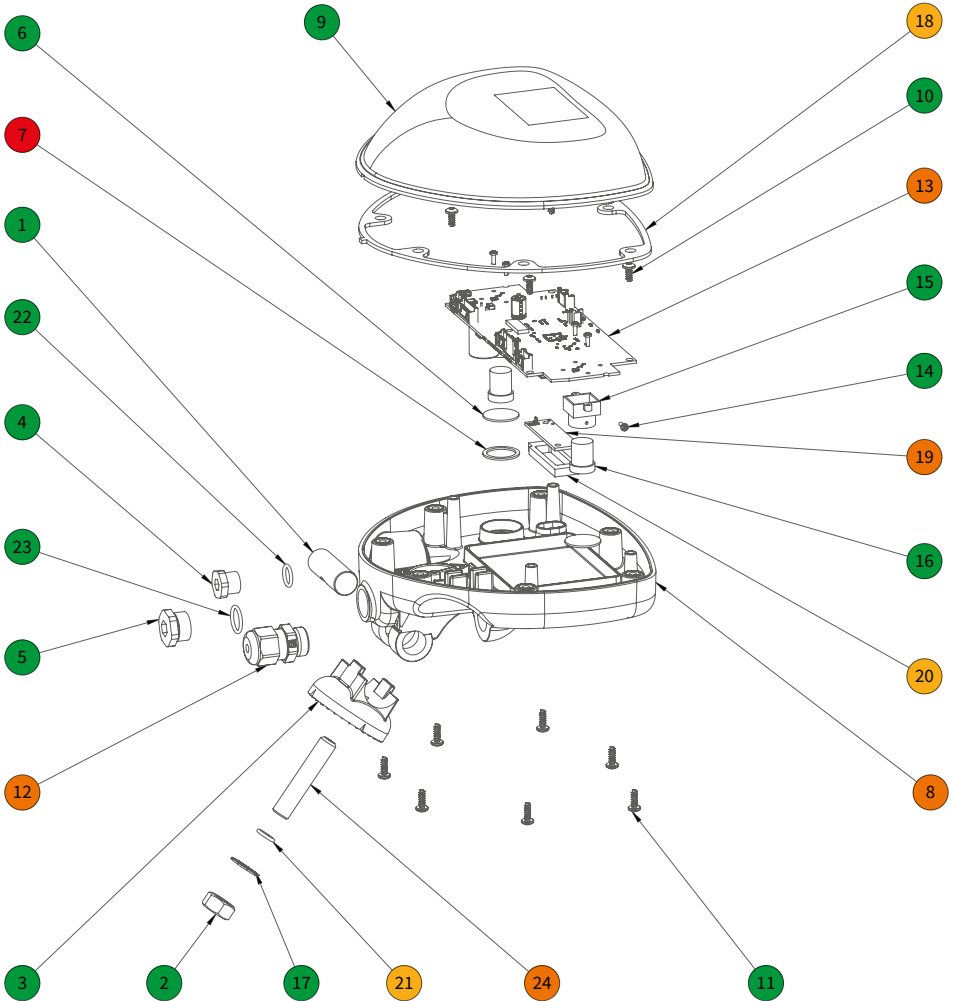

| Item | Qty | Material |
|------|-----|-----------------|
| 1 | 1 | Aluminium |
| 2 | 1 | Stainless Steel |
| 3 | 1 | Polycarbonate |
| 4 | 1 | Nylon |
| 5 | 1 | Nylon |
| 6 | 2 | Glass |
| 7 | 2 | HSAP |
| 8 | 1 | Polycarbonate |

| Item | Qty | Material |
|------|-----|-----------------------|
| 9 | 1 | Polycarbonate |
| 10 | 4 | Stainless Steel |
| 11 | 7 | Stainless Steel |
| 12 | 1 | Metal, Nylon, & PVC |
| 13 | 1 | Printed Circuit board |
| 14 | 6 | Stainless Steel |
| 15 | 2 | Aluminium |
| 16 | 2 | Mixed Metal & Glass |

| Item | Qty | Material |
|------|-----|-----------------------|
| 17 | 1 | Stainless Steel |
| 18 | 1 | Neoprene |
| 19 | 1 | Printed Circuit board |
| 20 | 1 | Nylon |
| 21 | 1 | Nitrile |
| 22 | 1 | EPDM |
| 23 | 1 | EPDM |
| 24 | 1 | Stainless Steel |

- Reuse / Recycle
- Separate & Recycle
- Downcycle
- Hazardous Recovery
- Non- Recyclable

SAFETY PRECAUTIONS

All work must be performed in accordance with company working practices, in-line with adequate risk assessments. Only skilled and instructed persons should carry out work with the product. Experience and safety procedures in the following areas may be relevant:

- **Working with mains power**
- **Working with modern electronic/electrical equipment**
- **Working at height**
- **Working at the roadside or highways**

1. This product is compliant to the Restriction of Hazardous Substances (RoHS - European Union directive 2011/65/EU).
2. The product must be correctly connected to the specified power supply. All connections must be made whilst the power supply is off or suitably isolated. Safety must always take precedence and power must only be applied when deemed safe to do so.
3. No user-maintainable parts are contained within the product. Removing or opening the outer casing is deemed dangerous and will void all warranties.
4. Under no circumstances should a product suspected of damage be powered on. Internal damage may be suggested by unusual behaviour, an unusual odour or damage to the outer casing. Please contact AGD for further advice.
5. This Product is Compliant with the European Radio Equipment Directive 2014/53/EU.
There is no restrictions of use within any EU Member state for this product.
This product is Receiver Category 2.





CERTIFICATE OF REGISTRATION

Company: AGD Systems Limited

We confirm that the products listed below have been registered with TOPAS Limited under reference 2019/0155 and meet the requirements provided under TOPAS 0600 and the TOPAS Specifications applicable.

Product Name: 641 Pedestrian Detector

Product Reference: 641

TOPAS Specifications: TOPAS 2507A

Exceptions/Limitations: Clause 2.20 & 2.27 (see below)

Director, Dr M E Pleydell

Signed.....
(on behalf of Traffic Open Products and Specifications Limited)

Dated.....
8/3/19

Website: www.topasgroup.org.uk
Email: enquiries@topasgroup.org.uk

TOPAS accepts no liability as to the compliance of this product other than as stated on the register of products at www.topasgroup.org.uk. Procurers are advised to confirm compliance of statutory regulations with the manufacturer.

Exceptions/Caveats:

AGD Signals Limited

Product 641 Pedestrian Detector

TOPAS 2507A
Clauses 2.20 & 2.27

Deviation from requirement: the unit needs up to 30 seconds instead of the required 5000 milliseconds to resume normal operations (Category 1 fault)

Disclaimer

While we (AGD Systems) endeavour to keep the information in this manual correct at the time of download or print, we make no representations or warranties of any kind, express or implied, about the completeness, accuracy, reliability, suitability or availability with respect to the information, products, services, or related graphics contained herein for any purpose.

Any reliance you place on such information is therefore strictly at your own risk. In no event will we be liable for any loss or damage including without limitation, indirect or consequential loss or damage, or any loss or damage whatsoever arising from loss of data or profits arising out of, or in connection with, the use of this manual.

WARRANTY

All AGD products are covered by a 12 month return to factory warranty. Products falling outside this period may be returned to AGD Systems for: evaluation, repair, update or re-calibration, any of which may be chargeable.

AGD[®]

PRODUCT SOLUTIONS FOR
INTELLIGENT TRAFFIC SYSTEMS

AGD Systems Limited White Lion House, Gloucester Road, Cheltenham, GL51 0TF, UK
Tel: +44 (0) 1452 854212 **Email:** info@agd-systems.com **Web:** agd-systems.com



 THE
TRAFFIC
GROUP

traffic.group